

SAFETY PRECAUTIONS

SERVICE WARNING

Only qualified service technicians who are familiar with safety checks and guidelines should perform service work. Before replacing parts, disconnect power source to protect electrostatically sensitive parts. Do not attempt to modify any circuit unless so recommended by the manufacturer. When servicing the receiver, use an isolation transformer between the line cord and power receptacle.

SERVICING THE HIGH VOLTAGE AND CRT

Use EXTREME CAUTION when servicing the high voltage circuits. To discharge static high voltage, connect a 10K ohms resistor in series with a test lead between the receiver and CRT anode lead. DO NOT lift the CRT by the neck. Always wear shatterproof goggles when handling the CRT to protect eyes in case of implosion.

X-RAY RADIATION AND HIGH VOLTAGE LIMITS

Be aware of the instructions and procedures covering X-ray radiation. In solid-state receivers and monitors, the CRT is the only potential source of X-rays. Keep an accurate high voltage meter available at all times. Check meter calibration periodically. Whenever servicing a receiver, check the high voltage at various brightness levels to be sure it is regulating properly. Keep high voltage at rated value, NO HIGHER. Excessive high voltage may cause X-ray radiation or failure of associated components. DO NOT depend on protection circuits to keep voltage at rated value. When troubleshooting a receiver with excessive high voltage, avoid close contact with the CRT. DO NOT operate the receiver longer than necessary. To locate the cause of excessive high voltage, use a variable AC transformer to regulate voltage. In present receivers, many electrical and mechanical components have safety related characteristics which are not detectable by visual inspection. Such components are identified by a # on both the schematic and the parts list. For SAFETY, use only equivalent replacement parts when replacing these components.

GENERAL GUIDELINES

Perform a final SAFETY CHECK before returning receiver to customer. Check repaired area for poorly soldered connections, and check entire circuit board for solder splashes. Check inner board wiring for pinched wires or wires contacting any high wattage resistors. Check that all control knobs, shields, covers, grounds, and mounting hardware have been replaced. Be sure to replace all insulators and restore proper lead dress.

The listing of any available replacement part herein in no case constitutes a recommendation, warranty, or guarantee by Howard W. Sams & Company as to the quality and suitability of such replacement part. The numbers of the listed parts have been compiled from information furnished to Howard W. Sams & Company by the manufacturers of the specific type of replacement part listed.

Reproduction or use, without express permission, of editorial or pictorial content, in any manner, is prohibited. No patent liability is assumed with respect to the use of the information contained herein.

©1997 by Howard W. Sams & Company
A Bell Atlantic Company
2647 Waterfront Parkway East Drive, Suite 100
Indianapolis, IN 46214-2012

Printed in the United States of America 5 4 3 2 1

SAFETY CHECKS -- FIRE AND SHOCK HAZARD

Cold Leakage Checks for Receivers with Isolated Ground

Unplug the AC cord, connect a jumper across the plug prongs, and turn the power switch on (if applicable). Use an ohmmeter to measure the resistance between the jumped AC plug and any exposed metal cabinet parts such as antenna screw heads, control shafts, or handle brackets. Exposed metal parts with a return path should measure between 1M ohms and 5.2M ohms. Parts without a return path must measure infinity.

Hot Leakage Current Check

Plug the AC cord directly into an AC outlet. DO NOT use an isolation transformer. Use a 1500 ohms, 10W resistor in parallel with a .15µF capacitor to connect between any exposed metal parts on the receiver and a good earth ground. (See figure below.) Use an AC voltmeter with at least 5000 ohms per volt sensitivity to measure the voltage across the resistor. Check all exposed metal parts and measure voltage at each point. Voltage measurements should not exceed .75VAC, 500µA. Any value exceeding this limit constitutes a potential shock hazard and must be corrected. If the AC plug is not polarized, reverse the AC plug and repeat exposed metal part voltage measurement at each point.

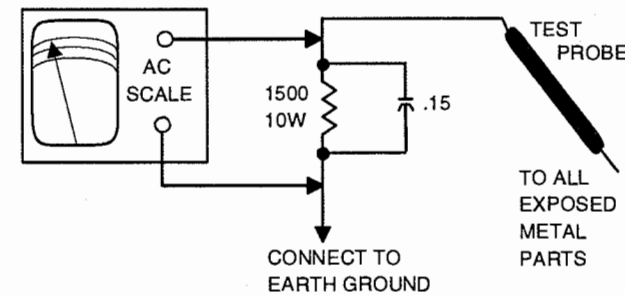

HIGH VOLTAGE SHUTDOWN TEST

Set all customer controls for normal picture. Check for 21.2V at TP651. Using an external power supply, apply 26.8V to TP651. The receiver should shutdown. If the receiver fails to shut down, the high voltage shutdown circuit requires repair. To return to normal operation, remove AC power and momentarily place a short between TP652 and TP653. Restore AC power and check receiver for proper operation.



97PF01259



0 81262 03911 3

3911

PHOTOFACT® Technical Service Data

3911

SET 3911

INDEX

GridTrace Location	
Main Board	3
High Voltage Shutdown Test	1
IC Functions	1
Important Parts Information	1
Miscellaneous Adjustments	1
Parts List	4
Placement Chart	2
Safety Precautions	1
Schematics	
Power Supply	2
System Control	2
Television	2
Schematic Notes	1
Test Equipment	1
Tuner Information	1

MODELS CJ13M10/15, 13J-M100/150, 14MJ10

SHARP

SHARP

Models CJ13M10/15, 13J-M100/150, 14MJ10

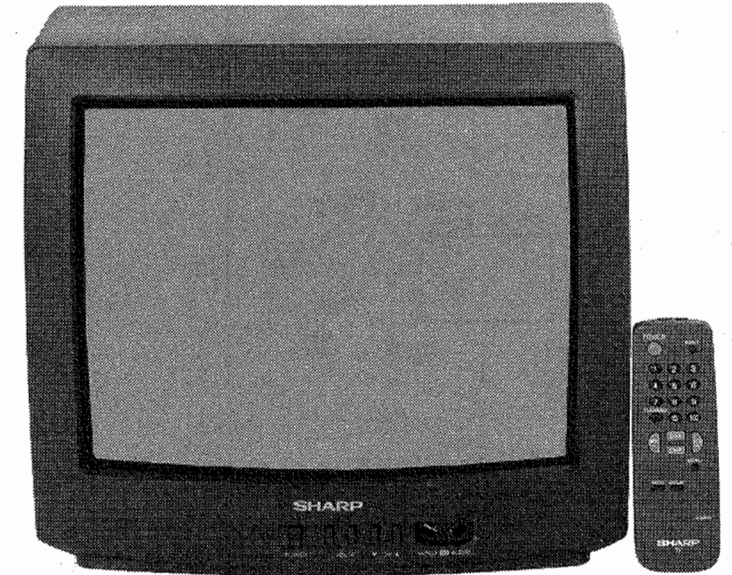

Model 13J-M100

Essential coverage
for servicing a television receiver...

- Schematics
- Component locations
- Parts list

For Supplier Address,
See PHOTOFACT Annual Index



HOWARD W. SAMS & COMPANY

DECEMBER 1997 SET 3911

TUNER INFORMATION

TUNER VOLTAGE CHART			
Pin	VHF Low Band	VHF High Band	UHF Band
AGC	5.8V	6.2V	5.9V
VT	2.7V	3.1V	3.0V
CLK	4.8V	4.8V	4.8V
DATA	4.8V	4.8V	4.8V
9V	4.9V	4.9V	4.9V
5V	5.1V	5.1V	5.1V
33V	33.0V	33.0V	33.0V
IF	0V	0V	0V

NOTE: VHF Low Band voltages taken on channel 2.
VHF High Band voltages taken on channel 7.
UHF Band voltages taken on channel 14.

TUNER TERMINAL GUIDE

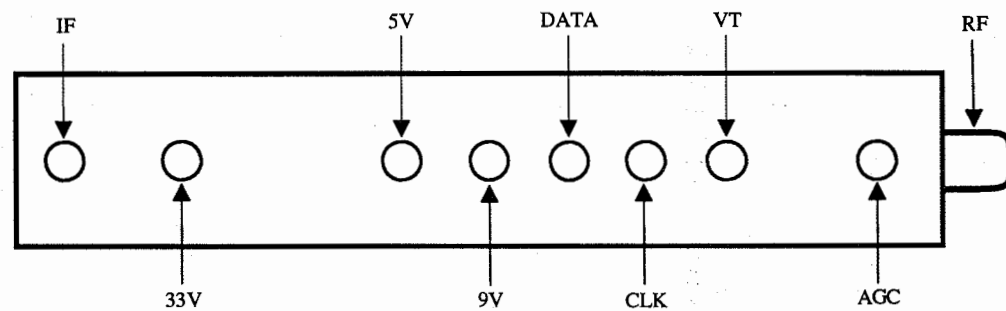

SCHEMATIC NOTES

For SAFETY use only equivalent replacement part, see parts list.

✕ Circuitry not used in some versions.

--- Circuitry used in some versions.

⊥ Ground

⊥ Chassis ground

∇ Common tie point

△ Taken from common tie point

3 Schematic **CIRCUITRACE**® Voltage source tie point.

A— Cabling: Heavy lines reduce use of multiple lines.

Waveforms and voltages are taken from ground, unless noted otherwise.
Waveforms taken with triggered scope and colorbar signal. Waveform voltage is peak to peak. Timebase is per division. Waveforms shown at 10 divisions.
Supply voltages maintained as seen at input.
Voltages measured with digital meter and a 1000 μ V RF signal, with colorbar pattern, applied to antenna terminal. Controls adjusted for normal operation.
Capacitors are 50 volts or less, 5% or greater unless noted. Electrolytic capacitors are 50 volts or less, 20% or greater unless noted.
Resistors are 1/2W or less, 5% or greater unless noted. Value in () used in some versions.
Measurements with switching as shown, unless noted. Rated voltage shown on zener diodes.

MISCELLANEOUS ADJUSTMENTS

HIGH VOLTAGE CHECK

Tune in a picture. Set brightness, color, picture, and screen control to minimum. Connect a high voltage probe to CRT anode. High voltage should measure 21.5kV to 23kV.

COLOR PURITY

Operate the receiver for 15 minutes. Tune in a green raster. Use a degaussing coil to demagnetize the CRT and mounting brackets. Loosen the deflection yoke clamp screw and slide the deflection yoke backward to obtain a vertical green band. Rotate and spread the purity magnet tabs until the green band is centered on the screen. Move the deflection yoke forward to obtain a uniform green screen.

CONVERGENCE

Operate the receiver for 15 minutes. Connect a color bar generator to the antenna terminals and tune in a dot pattern. Adjust the 4-pole magnet tabs to converge the red and blue dots at the center of the screen. Adjust the 6-pole magnet tabs to converge the red/blue dots over the green dots at the center of the screen.

NOTE: Rotate the two tabs of each set of magnets equally and opposite to converge vertically and rotate both tabs in the same direction to converge horizontally. Since the 4-pole and 6-pole magnets interact, repeat the adjustment until center convergence is correct.

Tune in a crosshatch pattern and remove the rubber wedges between the deflection yoke and the CRT. Tilt the deflection yoke up or down to converge the vertical lines at top and bottom of screen and the horizontal lines at the right and left sides of the screen. Tilt the deflection yoke right or left to converge horizontal lines at top and bottom of screen and the vertical lines at the right and left sides of the screen. Repeat convergence procedure if necessary to obtain best overall convergence.

CRT NECK ASSEMBLY

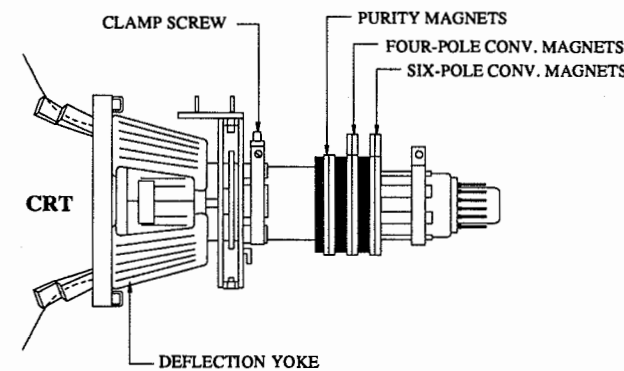

ENTERING SERVICE MODE

Service mode adjustments are required when IC201 and IC2101 are replaced. If the CRT is replaced then perform only adjustments relating to the picture tube.

Turn on receiver and use reset function in the video adjustment menu to ensure that customer controls are in their proper reset position. To enter the service mode, remove the AC power, and press and hold the channel up and volume up buttons while restoring AC power. The receiver will come on with the service mode displayed.

When in the service mode a letter S with a number is displayed in the upper left part of the screen and the data number is displayed in the upper center part of the screen. The current channel number is displayed in the upper right part of the picture. The S number is the service adjustment and it is changed by pressing the channel up / down buttons on the receiver or remote transmitter. The data number is the present data value of the service adjustment and it can be changed by pressing the volume up / down buttons on the receiver or remote transmitter. For a complete listing of the service adjustments, refer to the "Service Mode Adjustment Chart".

EXIT SERVICE MODE

Turn off the power or unplug the receiver to exit service mode.

RESETTING TO INITIAL VALUES

The initial values are written to IC2101 by entering the service mode and pressing the channel up and down buttons for more than two seconds.

RF AGC

Tune in a picture. Enter the service mode and select service number S08. Set the data value to a point where no snow (noise) appears in picture. Exit the service mode to select another channel. Check all channels for proper operation.

CAPTION POSITION

Enter the service mode and select service number S18. A black text box appears on screen. Adjust data value to center text box.

VCO

Connect a digital voltmeter to pin 44 of IC201 and ground. Tune in a local channel. Enter the service mode and select service number S10. Set the data value to obtain 2.2V on the digital voltmeter.

WHITE BALANCE

Operate the receiver for 15 minutes. Enter the service mode and select service number S03. Set the data value to 00. Set brightness for a visible raster. Alternately adjust data value of S14 and S15 until a good gray scale with normal white is obtained. Select service number S03. Set the data value for normal color level.

GRAY SCALE

Connect a digital voltmeter between TP852 and TP853 on the CRT board. Tune in an active channel. Set color, brightness, and picture to minimum. Enter the service mode and select service number S04 and adjust the data value to obtain .17V on the digital voltmeter. Adjust screen control, if necessary, to obtain a barely visible raster. Adjust service numbers S11, S12, S13, for a good gray scale with normal white at high and low brightness. Set color to midrange. Adjust screen control for normal brightness.

MISCELLANEOUS ADJUSTMENTS continued

IC FUNCTIONS

SERVICE MODE ADJUSTMENT CHART

Service No.	Service Adjustment	Data Range	Data Initial Value	Data On-Set Value	Notes
S01	Sub Picture	00-7F	55	56	Set brightness to minimum, picture to maximum. Adjust for normal contrast range.
S02	Sub Tint	00-7F	46	3D	Adjust for normal flesh tones.
S03	Sub Color	00-7F	32	35	Adjust for normal color level.
S04	Sub Brightness	00-7F	40	4B	Adjust for normal brightness level.
S05	Sharpness	00-3F	28	24	Adjust for proper sharpness of picture. Center of range is 28.
S06	Vertical Phase	00-07	00	01	Adjust for best vertical centering.
S07	Horizontal Position	00-1F	12	13	Adjust for best horizontal centering on screen.
S08	RF AGC	00-3F	2A	1F	"00" produces black raster
S09	Vertical Size	00-3F	20	1A	Adjust for proper vertical size with best linearity.
S10	VCO	00-7F	2C	22	-
S11	Red Cutoff	00-FF	00	4D	-
S12	Green Cutoff	00-FF	00	00	-
S13	Blue Cutoff	00-FF	00	2A	-
S14	Green Gain	00-FF	7F	95	-
S15	Blue Gain	00-FF	7F	89	-
S16	3.58MHz Trap	00, 01	00	00	"00"= On, "01"= Off
S17	Balance	00-3F	20	20	Adjust for proper audio balance. Center of range is 20.
S18	Caption Position	00-7F	18	13	Adjust to center the black box on the screen.
S19	Y-Mute	00, 01, 03	00	00	"00"=Normal picture, "01"=No Y, and "03"=Vertical collapse

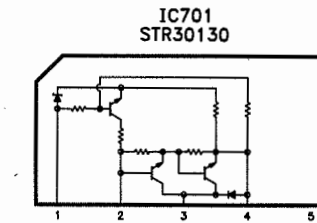

TEST EQUIPMENT

Test equipment listed by participating manufacturer illustrates typical or equivalent equipment used by Sams engineers to obtain measurements. This equipment is compatible with most types used by field service technicians.

Equipment	Sencore No.	Equipment	Sencore No.
Oscilloscope	SC3100	Isolation Transformer	PR57
Generators		Capacitance Analyzer	LC101, LC102
RGB	CM2000	CRT Analyzer	CR70
Multiburst Signal	VG91	AC Leakage Tester	PR57
Color Bar	VG91	Inductance Analyzer	LC101, LC102
TV Stereo	VG91	Flyback Yoke Tester	TVA92
Digital VOM	SC3100	TV Stereo Power Monitor	SR68, PA81
Frequency Meter	SC3100	Field Strength Meter	SL750
Hi-Voltage Probe	HP200	Transistor Tester	TF46
Accessory Probes	TP212	Video Analyzer	VG91, TVA92

Important Parts Information

- The parts listed here are those not usually available from a well-stocked supply cabinet or bin.
- Where items may be replaced with equivalent parts, several alternates are shown from participating vendors.
- On the parts lists, safety items are marked with a # to remind you that only exact replacements are recommended for these items.
- When ordering parts, state the model number, part number, and description.

Obtaining Parts

Many of these parts are available from your local Sams authorized distributor or the manufacturer of the equipment. Call Sams for the name of your nearest distributor:

800-428-7267

Or consult the Sams *Annual Index* for the address of the original equipment manufacturer.

Participating Vendors

Information on test equipment and replacement parts is listed in these pages for the following participating vendors. Consult the Sams *Annual Index* for their current address.

- Custom Components Corporation (Chek-A-Color)
- NTE Electronics, Inc. (NTE)
- Philips ECG Company (ECG)
- PTS Electronics Corporation (PTS)
- Sencore, Inc.
- Terrell & Nobis (TNI Electronics)
- Thomson Consumer Electronics, Inc. (SK, TCE)



Created with pride by the employees
of Howard W. Sams & Company.

*J. Barker, N. Beck, A. Bonner,
B. Buchanan, T. Clensy,
G. Farrell, B. Fink, M. Herkless,
J. Kocha, F. Malek, B. Medaris,
R. Raus, B. Skinner*

A

B

TELEVISION SCHEMATIC

ADDITIONAL SCHEMATIC NOTES, SEE PAGE 1

A PHOTOFAC STANDARD NOTATION SCHEMATIC WITH CIRCUITRACE[®] © Howard W. Sams & Co. 1997

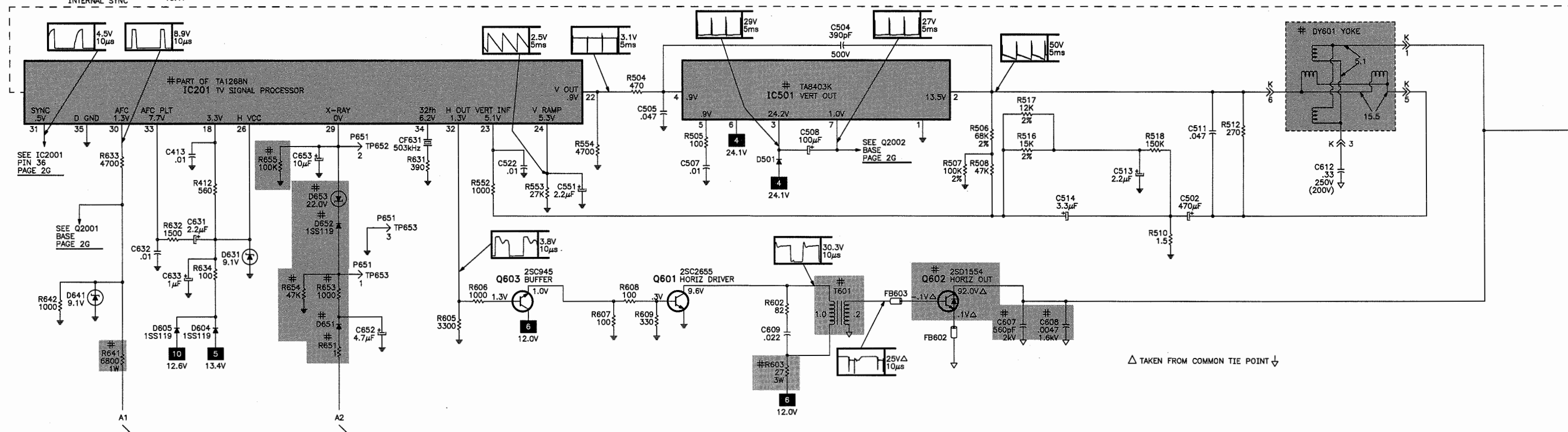
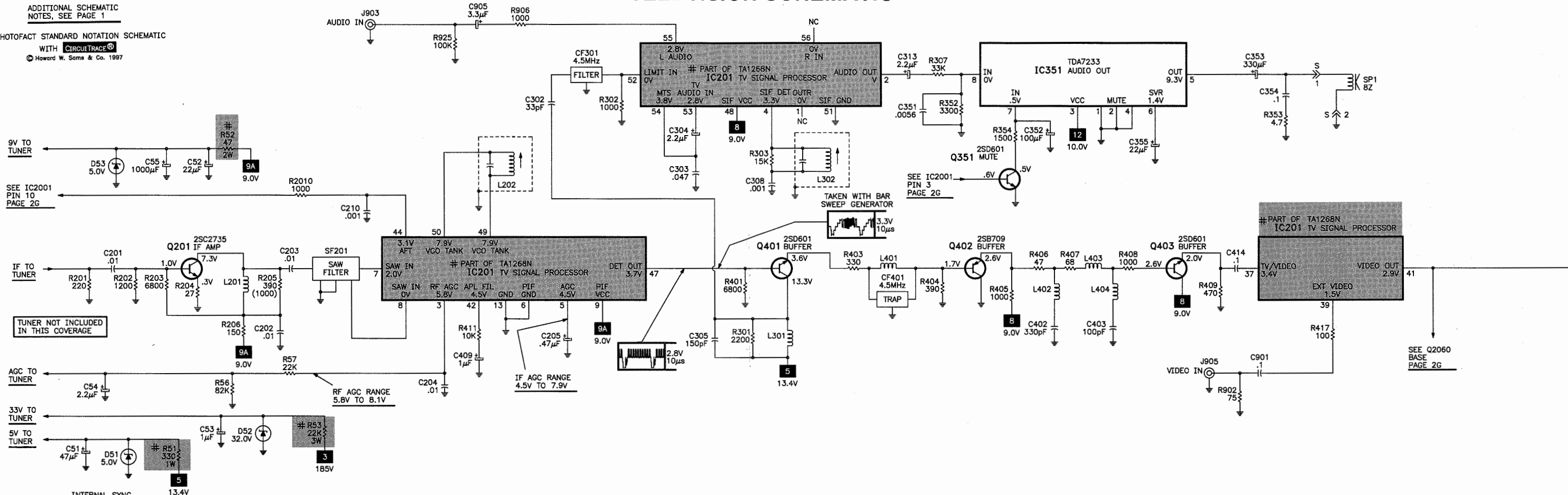

△ TAKEN FROM COMMON TIE POINT ↓

TELEVISION SCHEMATIC continued

C

D

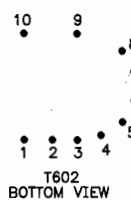
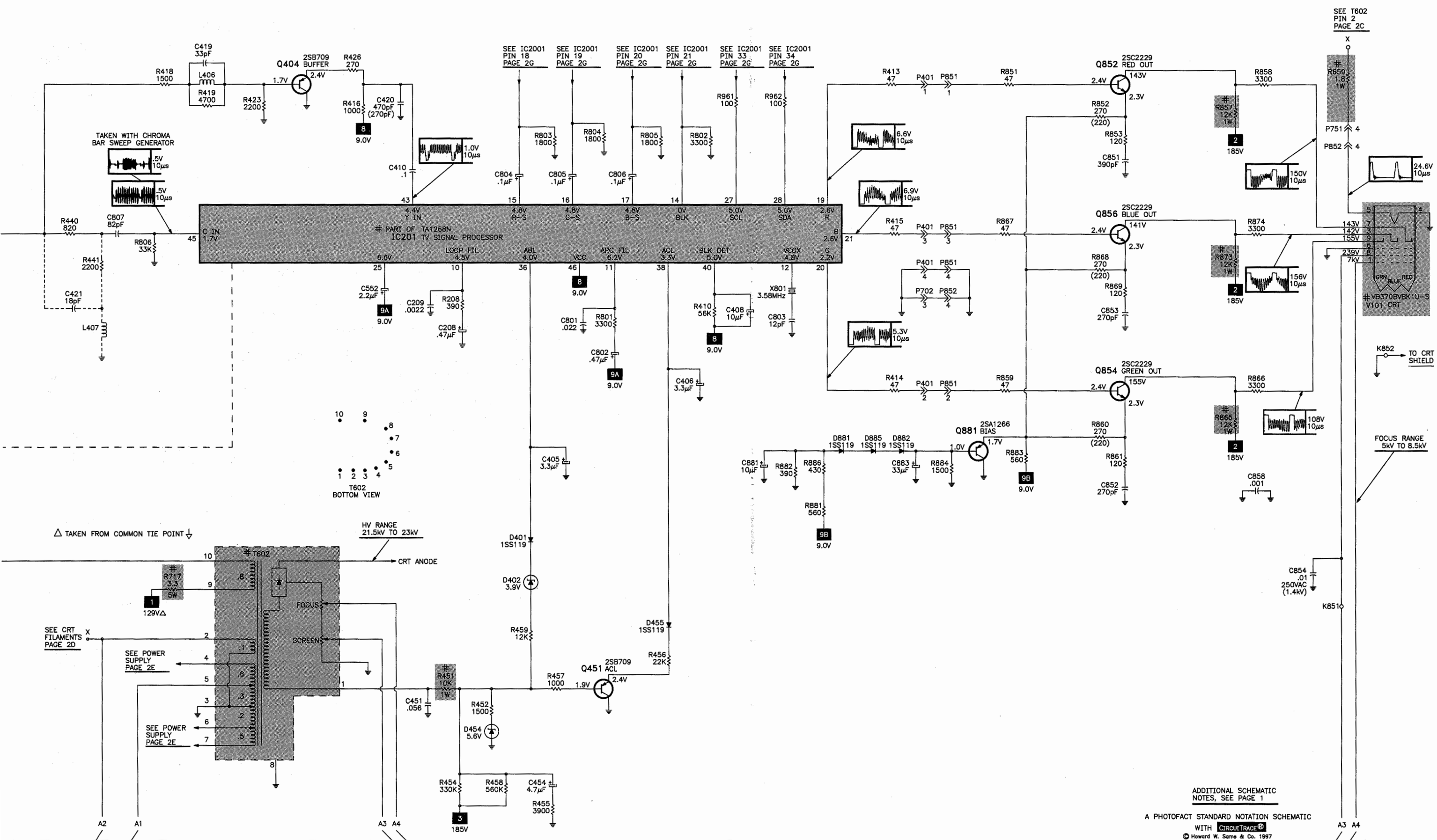

ADDITIONAL SCHEMATIC NOTES, SEE PAGE 1

A PHOTOFACIT STANDARD NOTATION SCHEMATIC WITH CIRCUITRACE

© Howard W. Sams & Co. 1997

POWER SUPPLY SCHEMATIC

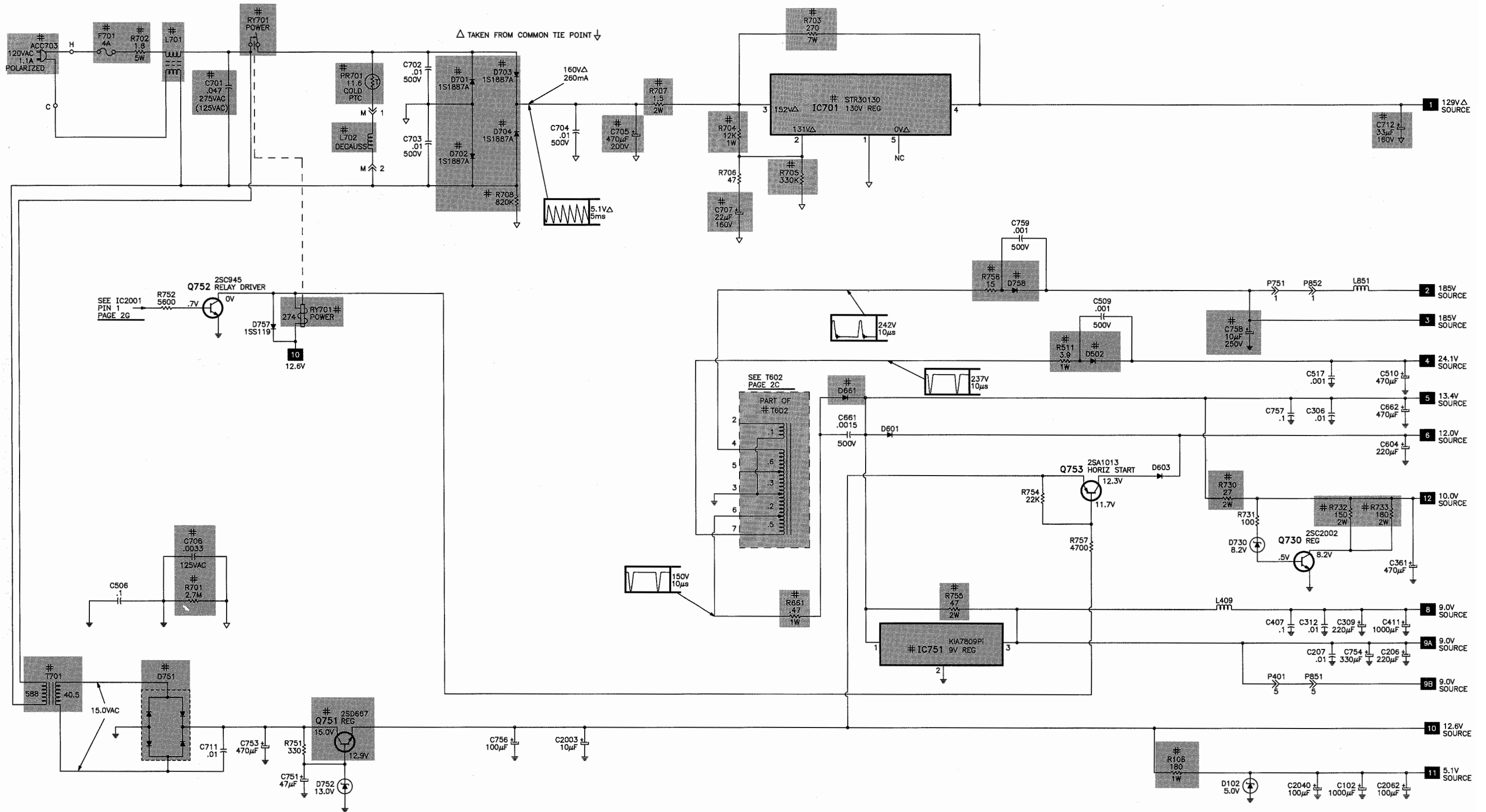

ADDITIONAL SCHEMATIC NOTES, SEE PAGE 1

A PHOTOFAC STANDARD NOTATION SCHEMATIC

WITH CIRCUITRACE

© Howard W. Sams & Co. 1997

SYSTEM CONTROL SCHEMATIC

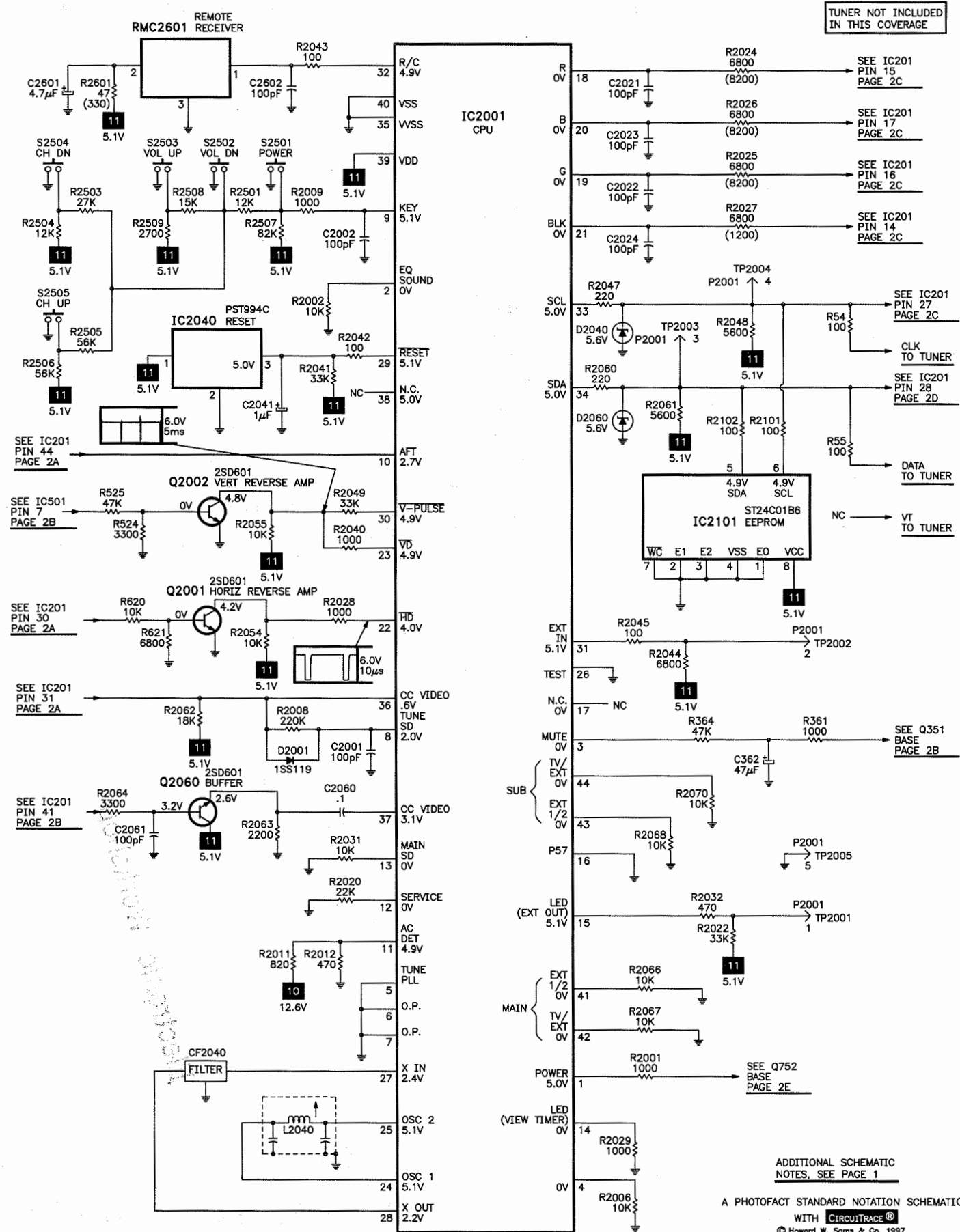

PLACEMENT CHART

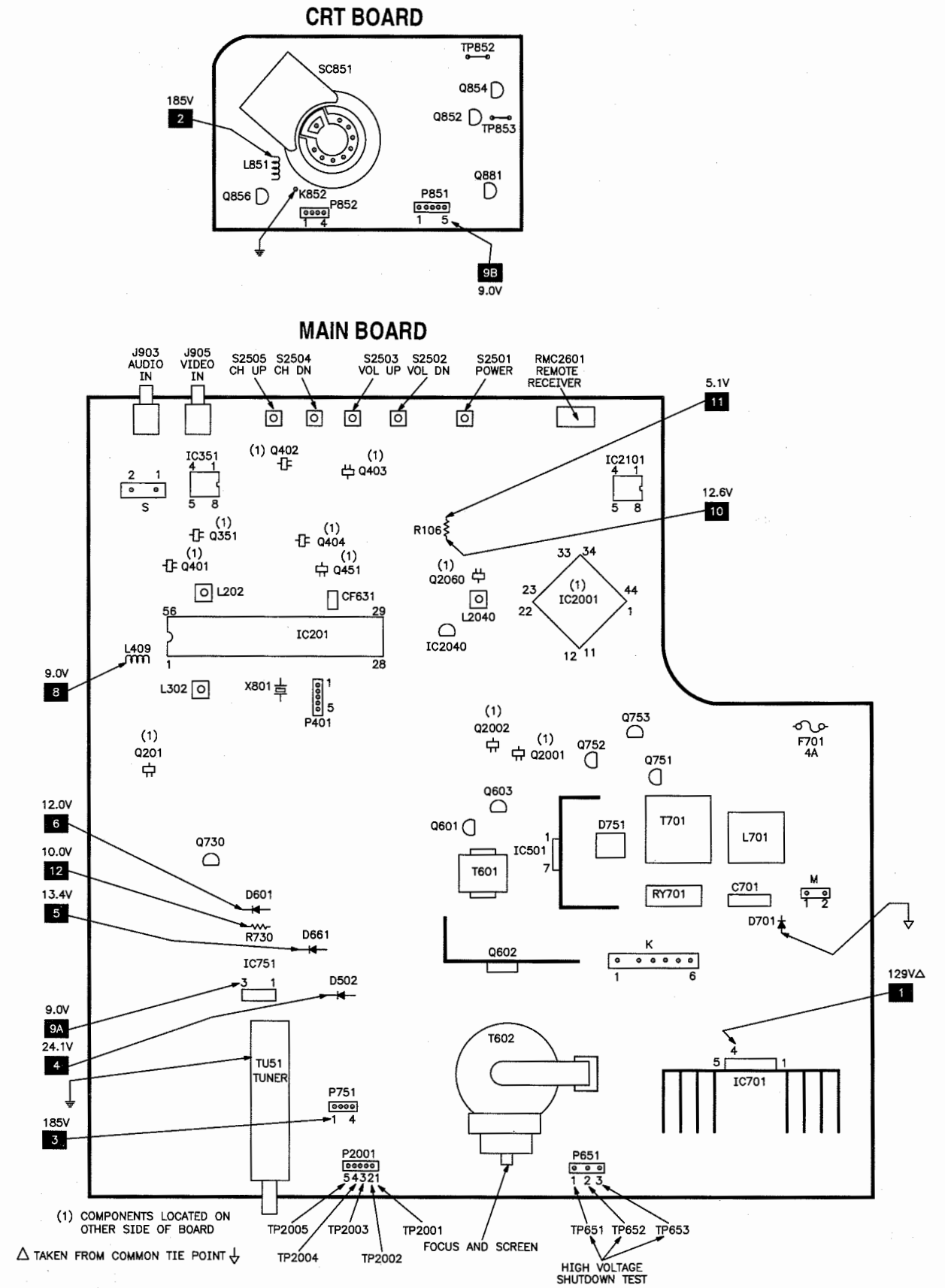

MAIN BOARD - TOP VIEW

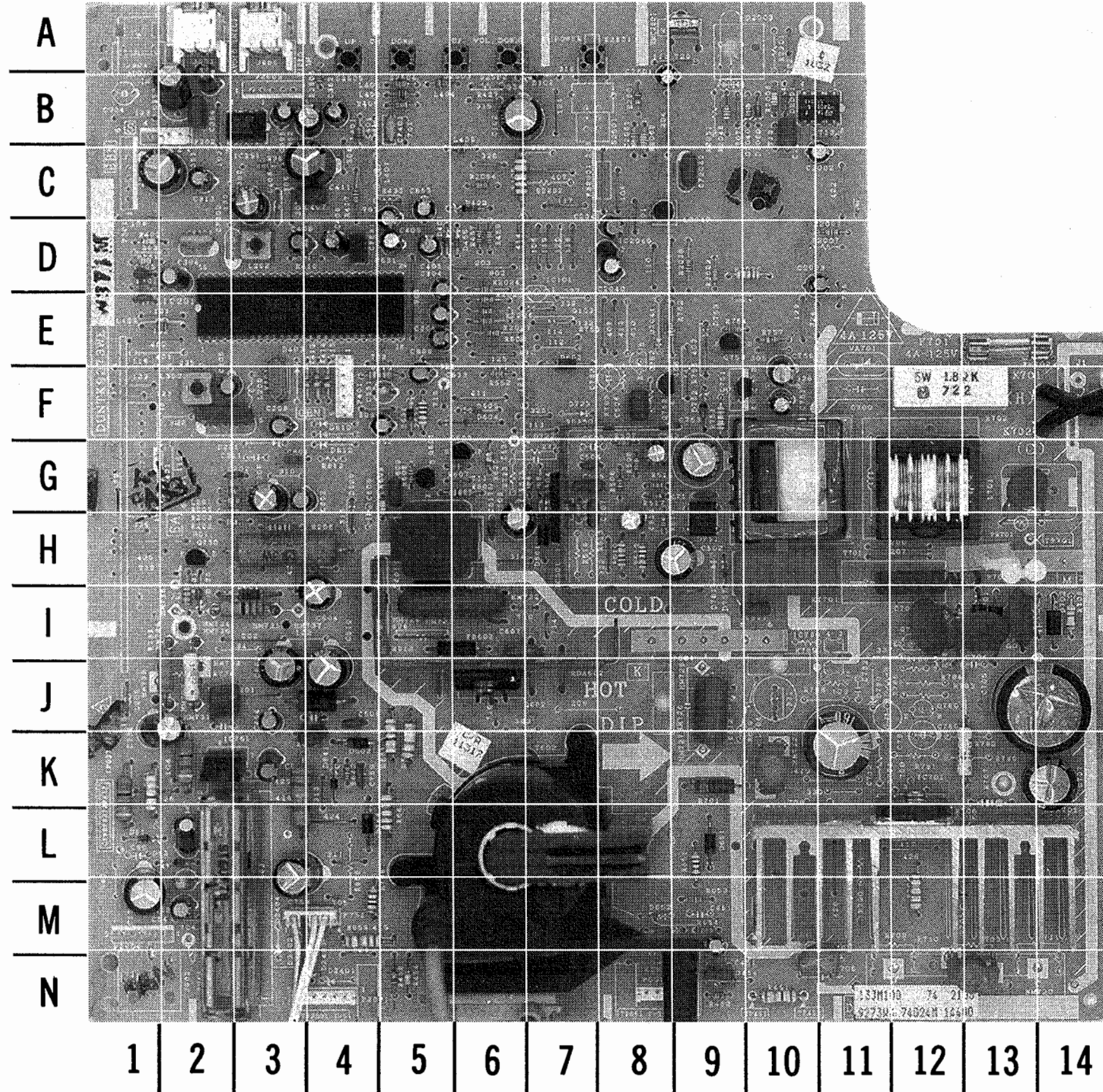

MAIN BOARD - TOP VIEW, GRIDTRACE LOCATION GUIDE

C51	L-2	C701	H-12	D701	I-13	R53	K-3	R704	M-12
C52	M-2	C702	I-12	D702	I-14	R106	C-6	R705	G-8
C53	K-3	C703	I-13	D703	I-13	R202	H-2	R706	K-13
C54	M-2	C704	I-13	D704	I-13	R203	G-3	R707	K-13
C55	M-1	C705	J-14	D730	I-3	R205	G-3	R708	I-14
C102	B-6	C706	N-11	D751	H-9	R206	H-3	R717	K-10
C202	G-3	C707	K-14	D752	F-9	R301	D-1	R730	I-3
C205	F-2	C711	G-9	D757	H-9	R361	C-3	R731	I-2
C206	G-3	C712	K-11	D758	L-4	R403	D-1	R732	J-2
C208	F-3	C751	F-10	D2101	B-10	R405	B-5	R733	J-2
C304	D-2	C753	G-9	D2040	B-10	R410	D-3	R751	F-9
C305	D-1	C754	J-2	D2060	B-10	R412	F-5	R752	E-9
C306	E-1	C756	F-10	F701	E-13	R413	F-4	R754	E-9
C309	C-3	C757	J-2	FB602	I-6	R414	F-4	R755	K-2
C313	C-2	C758	L-3	FB603	H-5	R415	F-4	R757	E-10
C352	B-4	C759	K-4	FH701	E-13	R417	C-4	R758	M-4
C353	B-2	C801	G-3	FH702	E-14	R451	N-10	R2001	D-11
C354	B-2	C802	G-3	IC201	E-2	R452	N-9	R2008	B-10
C355	B-3	C804	D-5	IC351	B-3	R454	N-5	R2020	D-10
C361	C-2	C805	E-5	IC501	G-7	R455	K-4	R2022	D-9
C362	B-4	C806	E-5	IC701	L-12	R457	D-6	R2024	D-6
C405	D-5	C807	E-5	IC751	K-2	R458	N-5	R2025	E-6
C406	D-4	C905	B-2	IC2001	B-11	R459	D-6	R2026	E-6
C407	C-4	C2003	D-11	IC2040	D-8	R504	G-7	R2027	E-6
C408	D-4	C2040	D-8	J903	A-2	R505	B-5	R2028	D-9
C409	C-5	C2041	D-8	J905	A-3	R506	G-8	R2048	B-9
C411	C-4	C2060	B-10	K	I-8	R507	F-8	R2063	B-8
C451	N-9	C2061	B-8	L201	G-3	R508	G-8	R2064	C-6
C454	J-3	C2062	C-11	L202	D-3	R510	H-8	R2506	B-4
C502	H-9	C2601	B-8	L301	D-1	R511	K-5	R2601	B-8
C504	G-7	CF301	D-2	L302	F-2	R512	H-8	RMC2601	A-9
C505	G-7	CF401	B-5	L401	B-4	R516	G-8	RY701	H-10
C506	F-8	CF631	D-4	L402	B-5	R517	G-8	S	B-2
C507	G-7	CF2040	C-9	L403	B-5	R518	H-8	S2501	A-7
C508	H-6	D51	L-1	L404	B-5	R525	G-7	S2502	A-6
C509	J-4	D52	K-2	L406	C-6	R552	F-6	S2503	A-6
C510	J-4	D53	L-2	L409	E-2	R602	G-6	S2504	A-5
C511	I-10	D102	B-7	L701	G-12	R603	H-3	S2505	A-4
C513	G-8	D401	D-5	L2040	C-8	R606	E-6	SF201	F-2
C514	H-8	D402	C-6	M	H-14	R607	G-6	T601	H-5
C517	H-6	D454	N-9	P401	F-4	R608	G-5	T602	L-6
C551	F-5	D455	D-5	P651	N-8	R609	G-5	T701	G-10
C552	F-5	D501	H-7	P751	M-4	R620	G-6	TP651	N-8
C604	I-4	D502	K-4	P2001	N-4	R634	F-5	TP652	N-8
C607	I-6	D601	I-3	PR701	G-13	R641	L-5	TP653	N-8
C608	I-5	D603	E-7	Q601	G-5	R642	K-4	TP2001	N-4
C609	G-5	D604	F-6	Q602	J-6	R651	L-9	TP2002	N-4
C612	J-9	D605	F-6	Q603	G-6	R653	M-9	TP2003	N-4
C631	D-5	D631	F-5	Q730	H-2	R654	M-9	TP2004	N-4
C633	F-5	D641	K-4	Q751	F-10	R659	M-4	TP2005	N-4
C652	M-9	D651	L-9	Q752	F-8	R661	K-5	TU51	M-2
C653	C-5	D652	M-8	Q753	E-9	R701	K-9	X801	F-3
C661	K-4	D653	M-8	R51	K-1	R702	F-12		
C662	J-3	D661	J-4	R52	K-1	R703	N-13		

MAIN BOARD - BOTTOM VIEW

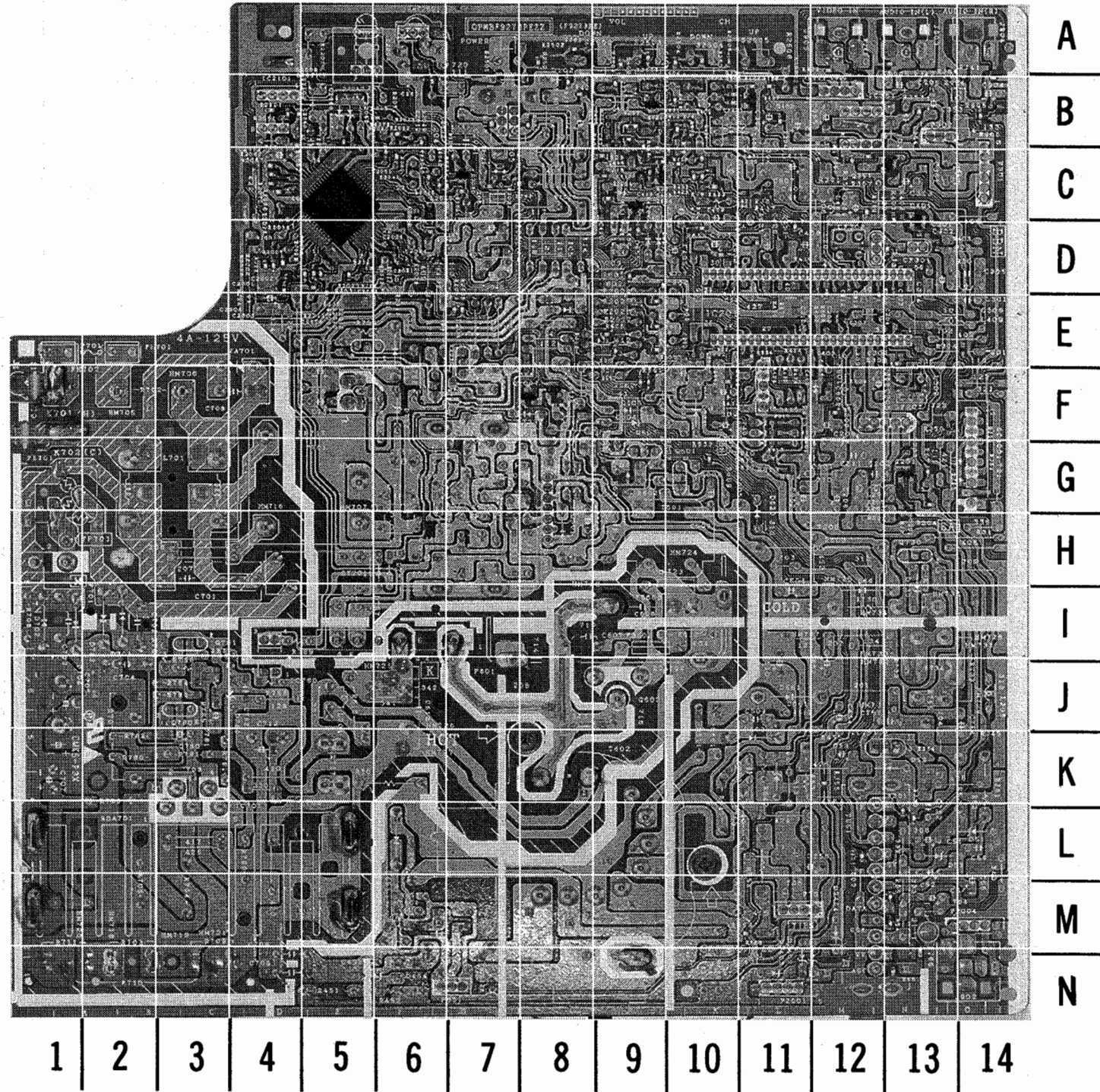

MAIN BOARD - BOTTOM VIEW, GRIDTRACE LOCATION GUIDE

C201	G-13	C2022	D-6	R352	C-12	R633	G-10	R2043	B-6
C203	F-13	C2023	D-6	R353	B-13	R655	D-10	R2044	C-6
C204	E-13	C2024	D-6	R354	B-11	R801	G-12	R2045	C-6
C207	E-12	C2602	B-7	R364	B-11	R802	E-11	R2047	C-6
C209	F-12	IC2001	C-5	R401	C-12	R803	E-9	R2049	B-6
C210	D-12	Q201	G-13	R404	B-11	R804	E-9	R2054	D-7
C302	D-13	Q351	C-13	R406	B-10	R805	E-9	R2055	D-7
C303	D-13	Q401	C-13	R407	B-10	R806	D-11	R2060	B-5
C308	F-13	Q402	B-11	R408	B-9	R902	A-12	R2061	B-4
C312	D-12	Q403	B-9	R409	B-9	R906	B-14	R2062	B-4
C351	C-12	Q404	C-9	R411	D-11	R925	A-13	R2066	C-4
C402	B-10	Q451	C-9	R416	B-8	R961	F-9	R2067	C-4
C403	B-10	Q2001	F-8	R418	B-9	R962	F-9	R2068	C-4
C410	C-9	Q2002	F-8	R419	B-9	R2002	D-4	R2070	C-4
C413	F-11	Q2060	C-7	R423	C-10	R2006	D-4	R2101	B-4
C414	B-9	R54	M-13	R426	C-9	R2009	D-5	R2102	B-5
C419	C-9	R55	M-13	R440	C-10	R2010	D-5	R2501	A-8
C420	C-8	R56	N-13	R456	C-10	R2011	D-5	R2503	A-10
C522	E-10	R57	G-13	R524	F-8	R2012	D-5	R2504	A-10
C632	D-10	R201	L-13	R553	F-10	R2029	C-7	R2505	A-10
C803	F-12	R204	F-12	R554	F-10	R2031	D-5	R2507	B-8
C901	A-12	R208	F-12	R605	D-9	R2032	D-6	R2508	A-9
C2001	D-4	R302	D-2	R621	G-9	R2040	D-6	R2509	A-9
C2002	D-4	R303	F-13	R631	D-10	R2041	C-7		
C2021	D-6	R307	B-12	R632	D-10	R2042	C-6		

A HOWARD W. SAMS GRIDTRACE™ PHOTO

SHARP

MODELS CJ13M10/15, 13J-M100/150, 14MJ10

PARTS LIST

SEMICONDUCTORS

(Select the replacement that gives the best results.)

Item No.	Type No.	Mfr. Part No.	NTE Part No.	ECG Part No.	TCE Part No.
D51	-	RH-EX0611GEZZ	-	-	-
D52	-	RH-EX0701GEZZ	-	-	-
D53	-	RH-EX0611GEZZ	-	-	-
D102	-	RH-EX0611GEZZ	-	-	-
D401	1SS119	VHD1SS119//-1	NTE519	ECG519	SK3100
	-	RH-DX0446CEZZ	-	ECG177	-
	-	RH-DX0045GEZZ	NTE519	ECG519	SK3100
D402	-	RH-EX0092CEZZ	NTE5006A	ECG5006A	SK3A6
D454	-	RH-EX0103CEZZ	NTE5011A	ECG5011A	SK5A6
D455	1SS119	VHD1SS119//-1	NTE519	ECG519	SK3100
	-	RH-DX0446CEZZ	-	ECG177	-
	-	RH-DX0045GEZZ	NTE519	ECG519	SK3100
	-	RH-DX0441CEZZ	-	-	-
# D501	-	RH-DX0131CEZZ	NTE552	ECG552	SK9000
# D502	-	RH-DX0441CEZZ	-	-	-
D601, 03	-	RH-DX0110CEZZ	NTE116	ECG116	SK3312
D604	-	RH-DX0441CEZZ	-	-	-
	1SS119	VHD1SS119//-1	NTE519	ECG519	SK3100
	-	RH-DX0110CEZZ	NTE116	ECG116	SK3312
D605	-	RH-DX0441CEZZ	-	-	-
	1SS119	VHD1SS119//-1	NTE519	ECG519	SK3100
	-	RH-DX0110CEZZ	NTE116	ECG116	SK3312
D631	-	RH-EX0630GEZZ	-	-	-
D641	-	RH-EX0631GEZZ	-	-	-
# D651	-	RH-DX0131CEZZ	NTE552	ECG552	SK9000
# D652	1SS119	VHD1SS119//-1	NTE519	ECG519	SK3100
	-	RH-DX0446CEZZ	-	ECG177	-
	-	RH-DX0045GEZZ	NTE519	ECG519	SK3100
# D653	-	RH-EX0091CEZZ	NTE5030A	ECG5030A	SK22A
# D661	-	RH-DX0444CEZZ	-	-	-
# D701 Thru					
# D704	1S1887A	RH-DX0154CEZZ	NTE552	ECG552	SK9000
D730	-	RH-EX0310CEZZ	-	-	-
# D751	-	RH-DX0417CEZZ	NTE5332	ECG5332	SK9230
	-	RH-DX0200CEZZ	NTE5332	ECG5332	SK9232
D752	-	RH-EX0019TAZZ	NTE5022A	ECG5022A	SK13A
D757	1SS119	VHD1SS119//-1	NTE519	ECG519	SK3100
	-	RH-DX0446CEZZ	-	ECG177	-
	-	RH-DX0045GEZZ	NTE519	ECG519	SK3100
# D758	-	RH-DX0131CEZZ	NTE552	ECG552	SK9000
D881, 82, 85	1SS119	VHD1SS119//-1	NTE519	ECG519	SK3100
	-	RH-DX0446CEZZ	-	ECG177	-
	-	RH-DX0045GEZZ	NTE519	ECG519	SK3100
D2001	1SS119	VHD1SS119//-1	NTE519	ECG519	SK3100
	-	RH-DX0446CEZZ	-	ECG177	-
	-	RH-DX0045GEZZ	NTE519	ECG519	SK3100
D2040	-	RH-EX0298CEZZ	-	-	-
D2060	-	RH-EX0298CEZZ	-	-	-
# IC201	TA1268N	RH-iX2933CEZZ	-	-	-
# IC201 (1)	-	RH-iX2573CEZZ	-	-	-
IC351	TDA7233	VHiTDA7233/-1	-	-	-
# IC501	TA8403K	VHiTA8403K/-1	-	-	-
# IC701	STR30130	VHiSTR301301E	NTE1777	ECG1777	SK9870
# IC751	KiA7809Pi	VHiKA7809Pi-1	NTE1966	ECG1966	-
	-	VHiTA7809S/-1	NTE1966	ECG1966	-
IC2001	-	RH-iX2942CEZZ	-	-	-
IC2040	PST994C	VHiPST994C/-1	-	-	-
IC2101	ST24C01B6	RH-iX2447CEN1	-	-	-
	-	RH-iX2448CEN1	-	-	-

For SAFETY use only equivalent replacement part.
 (1) Used in model 14MJ10.

SEMICONDUCTORS continued

(Select the replacement that gives the best results.)

Item No.	Type No.	Mfr. Part No.	NTE Part No.	ECG Part No.	TCE Part No.
Q201	2SC2735	VS2SC2735//IE	NTE2402	ECG2402	SK10095
Q351	2SD601(AR)	VS2SD601AR/-1	NTE2408	ECG2408	SK10099
	2SC2462	VS2SC2462-C-1	NTE2408	ECG2408	SK10099
Q401	2SD601(AR)	VS2SD601AR/-1	NTE2408	ECG2408	SK10099
	2SC2462	VS2SC2462-C-1	NTE2408	ECG2408	SK10099
Q402	2SB709(AR)	VS2SB709AR/-1	NTE2409	ECG2409	SK10100
Q403	2SD601(AR)	VS2SD601AR/-1	NTE2408	ECG2408	SK10099
	2SC2462	VS2SC2462-C-1	NTE2408	ECG2408	SK10099
Q404, 51	2SB709(AR)	VS2SB709AR/-1	NTE2409	ECG2409	SK10100
Q601	2SC2655(Y)	VS2SC2655Y/-1	NTE293	ECG293	SK3849
# Q602	2SD1554	VS2SD1554//IE	NTE2331	ECG2331	SK9422
	2SD2586	VS2SD2586//IE	-	-	-
Q603	2SC945(AQ)	VS2SC945AQ/-1	NTE85	ECG85	SK3124A
	2SC1815(Y)	VS2SC1815YW-1	NTE85	ECG85	SK3124A
	2SC3198(Y)	VS2SC3198-Y-1	NTE85	ECG85	SK9229
Q730	2SC2002	VS2SC2002-K1A	NTE85	ECG85	SK3449
# Q751	2SD667(D)	VS2SD667D//-1	NTE382	ECG382	SK9137
	2SC1983	VS2SC1983//-2	NTE56	ECG56	SK3929
Q752	2SC945(AQ)	VS2SC945AQ/-1	NTE85	ECG85	SK3124A
	2SC1815(Y)	VS2SC1815YW-1	NTE85	ECG85	SK3124A
	2SC3198(Y)	VS2SC3198-Y-1	NTE85	ECG85	SK9229
Q753	2SA1013	VS2SA1013//IE	NTE32	ECG32	SK3867A
Q852, 54, 56	2SC2229(O)	VS2SC2229O/IE	NTE399	ECG399	SK3244
Q881	2SA1266(Y)	VS2SA1266-Y-1	NTE290A	ECG290A	SK9132
	2SA1015(Y)	-	NTE290A	ECG290A	SK9132
Q2001, 02, 60	2SD601AR	VS2SD601AR/-1	NTE2408	ECG2408	SK10099
	2SC2462	VS2SC2462-C-1	NTE2408	ECG2408	SK10099

For SAFETY use only equivalent replacement part.

CONTROLS & RESISTORS

Item No.	Function/Rating	Mfr. Part No.	NTE Part No.
# PR701	11.6 Cold PTC	RMPTP0026CEZZ	-
# R51	330 5% 1W	VRS-VV3AB331J	1W133
# R52	47 5% 2W	VRS-VV3DB470J	2W047
# R53	22K 5% 3W	VRS-VV3LB223J	3W322
# R106	180 5% 1W	VRS-VV3AB181J	1W118
# R451	10K 5% 1W	VRS-VV3AB103J	1W310
R506	68K 2% 1/8W	VRD-RA2BE683G	-
R507	100K 2% 1/8W	VRD-RA2BE104G	EW410
# R511	3.9 5% 1W	VRN-VV3AB3R9J	1W3D9
R516	15K 2% 1/8W	VRD-RA2BE153G	EW315
R517	12K 2% 1/8W	VRD-RA2BE123G	EW312
# R603	27 5% 3W	VRS-SV3LB270J	3W027
# R641	6800 5% 1W	VRS-VV3AB682J	1W268
# R651	1.5 5% 1/2W	VRD-RM2HD1R0J	HW1D0
# R653	1000 5% 1/8W	VRD-RA2BE102J	EW210
# R654	47K 5% 1/8W	VRD-RA2BE473J	EW347
# R655	100K 5% .1W	VRN-MD2AL104J	-
# R659	1.8 5% 1W	VRN-VV3AB1R8J	1W1D8
# R661	.47 5% 1W	VRN-VV3ABR47J	1W47
# R701 (1)	2.7M 10% 1/2W	VRC-UA2HG275K	HW527
# R701 (2)	2.7M 10% 1/2W	VRC-UB2HG275K	HW527
# R702	1.8 10% 5W	VRW-KP3HC1R8K	5W1D8
# R703	270 5% 7W Wirewound	VRS-KA3NG271J	-
# R704	12K 5% 1W	VRS-VV3AB123J	1W312
# R705	330K 5% 1/4W	VRD-RA2EE334J	QW433
# R707	1.5 5% 2W	VRN-VV3DB1R5J	2W1D5
# R708	820K 5% 1/2W	VRD-RM2HD824J	HW482
# R717	3.3 10% 5W Wirewound	VRS-KA3HG3R3K	5W3D3
# R730	27 5% 2W	VRS-VV3DB270J	2W027
# R732	150 5% 2W	VRS-VV2DB151J	2W115
# R733	180 5% 2W	VRS-VV3DB181J	2W118
# R755	47 5% 2W	VRS-VV3DB470J	2W047
# R758	15 5% 1/2W	VRS-SV2HC150J	HW015
# R857, 65, 73	12K 5% 1W	VRS-VV3AB123J	1W312

For SAFETY use only equivalent replacement part.

PARTS LIST continued

COILS & TRANSFORMERS

Item No.	Function/Rating	Mfr. Part No.
# DY601 (1)	Yoke Horiz 3.9mH Vert 29.2mH	RCiLH0141PEZZ
# DY601 (2)	Yoke	RCiLH0142PEZZ
# DY601 (3)	Yoke	RCiLH0143PEZZ
# DY601 (4)	Yoke	RCiLH0144PEZZ
FB602	Ferrite Bead	RBLN-0037CEZZ
FB603	Ferrite Bead	RBLN-0037CEZZ
L201	1.2µH	VP-XF1R2K0000
L202	VCO	RCiLi0612CEZZ
	VCO	RCiLi0588CEZZ
L301	8.2µH	VP-XF8R2K0000
L302	SIF	RCiLi0613CEZZ
	SIF	RCiLi0605CEZZ
L401	6.8µH	VP-XF6R8K0000
L402	3.3µH	VP-XF3R3K0000
L403	10µH	VP-XF100K0000
L404	8.2µH	VP-XF8R2K0000
L406	68µH	VP-XF680K0000
L407	68µH	VP-XF680K0000
L409	10µH	VP-XF100K0000
# L701	Line Filter	RCiLF0235CEZZ
	Line Filter	RCiLF0087CEZZ
	Line Filter	RCiLF0289CEZZ
# L702	Degaussing	RCiLG0386PEZZ
L851	150µH	VP-DF151K0000
L2040	Oscillator	RCiLB0131CEZZ
# T601	Horizontal Driver	RTRNZ0168CEZZ
# T602 (5)	Horizontal Output	RTRNF0148PEZZ
# T701	Power	RTRNP0518CEZZ

For SAFETY use only equivalent replacement part.
 (1) Used with CRT A34KPU02XX.
 (2) Used with CRT 37GDA86X.
 (3) Used with CRT A34JFQ90X, CPJ370BVBK1S, and CPJ370BVBK1UBC.
 (4) Used with CRT A34JLL40X.
 (5) Focus and screen controls are part of T602.

CAPACITORS & ELECTROLYTICS

Item No.	Rating	Mfr. Part No.
C52	22µF 10% 16V Tantalum	VCSATA1CE226K
C551	2.2µF 10% 16V Tantalum	VCSATA1CE225K
# C607	560pF 10% 2kV	VCKYPH3DB561K
	560pF 10% 2kV	RC-KZ0338CEZZ
# C608	.0047 +50% -10% 1.6kV	VCFFPD3CA472H
# C701	.047 275VAC	-
	.047 125VAC	RC-FZ004SGEZZ
	.047 125VAC	RC-QZ005SCEZZ
	.047 125VAC	RC-FZ002SCEZZ
	.047 125VAC	RC-FZ027CUMZZ
	.047 125VAC	RC-FZ0279CEZZ
	.047 125VAC	RC-FZ015SCEZZ
# C705	470µF 200V	RC-EZ0422CEZZ
	470µF 200V	RC-EZ0522CEZZ
	470µF 200V	VCEAGH2DW227M
# C706	.0033 125VAC	RC-KZ0030CEZZ
	.0033 125VAC	RC-KZ0311CEZZ
	.0033 125VAC	RC-KZ0092CEZZ
# C707	22µF 20% 160V	VCEAGA2CW226M
# C712	33µF 160V	RC-EZ0638CEZZ
# C758	10µF 20% 250V	VCEAGA2EW106M
C854	.01 1.4kV	RC-K00161CEZZ
	.01 250VAC	-

For SAFETY use only equivalent replacement part.

MISCELLANEOUS

Item No.	Description	Mfr. Part No.	Notes
# ACC703	Line Cord	QACCD3051CESA	AC, Polarized
	Line Cord	QACCD3038CESA	AC, Polarized
	Line Cord	QACCD3037CESA	AC, Polarized
CF301	Filter	RFiLC0403CEZZ	4.5MHz
	Filter	RFiLC0029TAZZ	4.5MHz
CF401	Trap	RFiLC0013CEZZ	4.5MHz
CF631	Crystal	RFiLA0034CEZZ	503kHz
CF2040	Filter	RFiLC0121GEZZ	-
# F701	Fuse	QFS-B4023GEZZ	4Amp, 125V
	Fuse	QFS-B4021GEZZ	4Amp, 125V
FH701	Fuse Holder	QFSDH1013CEZZ	For F701
	Fuse Holder	QFSDH1009CEZZ	For F701
FH702	Fuse Holder	QFSDH1014CEZZ	For F701
	Fuse Holder	QFSDH1010CEZZ	For F701
J903	Jack	QJAKE0159CEZZ	Audio Input
J905	Jack	QJAKE0158CEZZ	Video Input
RMC2601	Receiver	RRMCU0222CEZZ	Remote
RMC2601	Receiver	RRMCU0216CEZZ	Remote
# RY701	Relay	RRLYU0036CEZZ	Power
	Relay	RRLYU0028CEZZ	Power
S2501	Switch	QSW-K0079GEZZ	Power
S2502	Switch	QSW-K0079GEZZ	Volume Down
S2503	Switch	QSW-K0079GEZZ	Volume Up
S2504	Switch	QSW-K0079GEZZ	Channel Down
S2505	Switch	QSW-K0079GEZZ	Channel Up
SC851	Socket	QSOVC0839CEZZ	CRT
SF201	Filter	RFiLC0405CEZZ	SAW
SP1	Speaker	VSP0080PBL08A	3" Round, 2W, 8 Ohms
	Speaker	VSP0080P-H28A	3" Round, 2W, 8 Ohms
	Speaker	VSP0080PBK58A	3" Round, 2W, 8 Ohms
# TU51 (1)(2)	Tuner	VTUVTST6UF78/	UHF/VHF, ST6UF78
# V101	CRT	VB370BVBK1U-S	CPJ370BVBK1UBC
	CRT	VB370BVBK1S-S	CPJ370BVBK1S
	CRT	VBA34JFQ90X/*S	A34JFQ90X
	CRT	VB34KPU02X/*S	A34KPU02XX
	CRT	VB34JLL40X/*S	A34JLL40X
	CRT	VB37GDA86X/1E	37GDA86X
X801	Crystal	RCRSB0001PEZZ	3.58MHz
	Crystal	RCRSB0205CEZZ	3.58MHz
	Adaptor	RUNTK0393CEZZ	Antenna, model 14MJ10.
	Antenna	QANTR0022PEZZ	Rod, models 13J-M100, 13J-M150, CJ13M10, and CJ13M15.
	Antenna	QANTR0010PEZZ	Rod, model 14MJ10.
	Magnet	PMAGF3041CEZZ	Purity/Convergence
	PC Board (1)	DUNTK9274WEW3	CRT
	PC Board (1)	DUNTK9273WEW3	Main, models 13J-M100 and 13J-M150.
	PC Board (1)	DUNTK9273WEW4	Main, models CJ13M10 and CJ13M15.
	PC Board (1)	DUNTK9273WEW5	Main, model 14MJ10.
	Transmitter	RRMCG1324CESA	Remote, models 13J-M100, 13J-M150, and CJ13M10
	Transmitter	RRMCG1324CESB	Remote, model CJ13M15.
	Transmitter	RRMCG1339CESA	Remote, model 14MJ10.
	Wedges	PSPAG0004PEZZ	Yoke Positioning (3 Used).

For SAFETY use only equivalent replacement part.

(1) Contact PTS Electronics Corporation for replacement; order by manufacturer's part number.
 (2) Contact TNI Electronics for replacement; order by part number on tuner.

CABINET PARTS

Item	Mfr. Part No.
Model CJ13M10	
Buttons	JBTN-0258PESA
Cabinet Front Assembly	CCABA2409WEV0
Cabinet Rear	GCABB2325PEKA
Model CJ13M15	
Buttons	JBTN-0258PESB
Cabinet Front Assembly	CCABA2409WEV2
Cabinet Rear	GCABB2325PEKB
Model 13J-M100	
Buttons	JBTN-0258PESA
Cabinet Front Assembly	CCABA2395WEV0
Cabinet Rear	GCABB2309PEKA
Model 13J-M150	
Buttons	JBTN-0258PESB
Cabinet Front Assembly	CCABA2395WEV2
Cabinet Rear	GCABB2309PEKB
Model 14MJ10	
Buttons	JBTN-0258PESA
Cabinet Front Assembly	CCABA2410WEV0
Cabinet Rear	GCABB2326PEKA
Remote Transmitter	
Battery Cover	GCOVA0078PEKA

SHARP

MODELS CJ13M10/15, 13J-M100/150, 14MJ10